

Maderla Collection - 62002/03



FEATURES

If you love the idea of a luxe look that won't break the bank, make yourself comfortable with this alluring light-hued sectional in an alluring walnut brown or neutral shade of pebble brown. Designed to look like the real thing, it's wrapped in a practical faux leather loaded with natural tonal variation and a soft hand feel. Appealing to a contemporary taste, its jumbo stitching, tufted styling and pillow top armrests are indulgently comfortable, with a streamlined look that tops off the high-end aesthetic made for everyday living.

SHOP THE COLLECTION



Oversized Accent Ottoman
-08



RAF Corner Chaise
-17



Sofa
-38



Ottoman
-14



Chair
-20



LAF Sofa
-66



LAF Corner Chaise
-16



Loveseat
-35



RAF Sofa
-67

AVAILABLE COLORS



Walnut



Pebble

Big or small... we fit your space.

MADERLA COLLECTION - 62002/03



Option 1

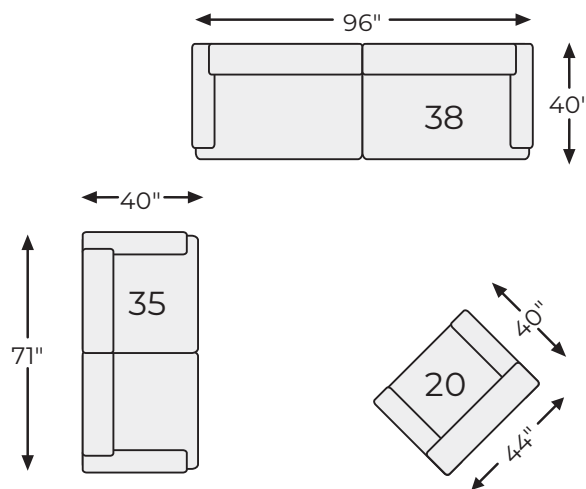

Option 2

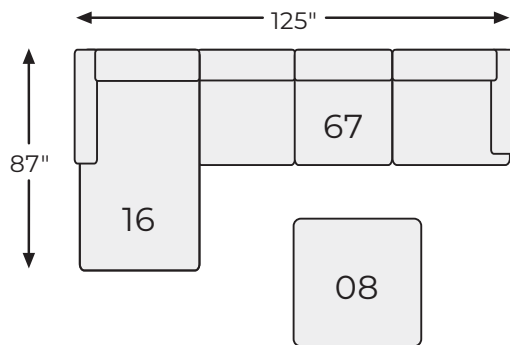

Option 3

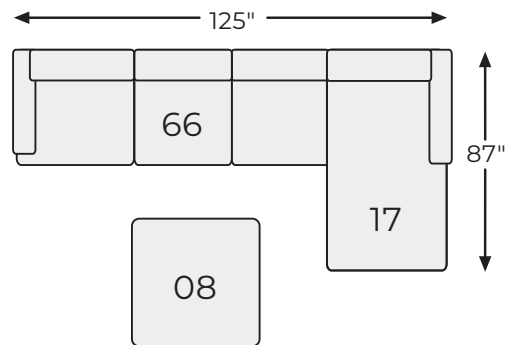

-08 OVERSIZED
ACCENT OTTOMAN

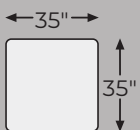

-14 OTTOMAN

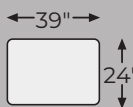

-38 SOFA

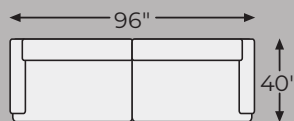

-35 LOVESEAT

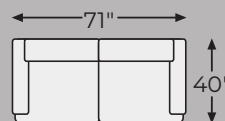

-16 LAF CORNER
CHAISE

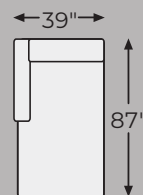

-17 RAF CORNER
CHAISE

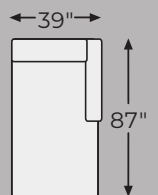

-20 CHAIR

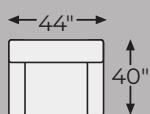

-66 LAF SOFA

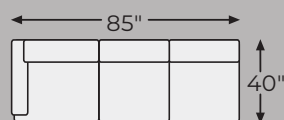

-67 RAF SOFA

